



Production license No.: SSYJXSCX No.2009-0088
Product Registration Standard: YZB/Su 1043-2011 Electric Wheelchair
Product registration certificate No.: SSYJX (Z) Zi 2011 No.2561072

Instruction Manual

Electric Wheelchair

Model: PL001



Before using the product, please read this Instruction Manual carefully for the purpose of correct operation, especially where it is marked with ★.

Guidance for Use	01
To Users	02
Safety Sign	03
Product Construction	04
Technical Parameter	06
Electromagnetic Interference	07
Guide for Safe Use	
Users	08
Escort	08
Precautions for Control Panel Use	09
Precautions for Static Wheelchair	09
Operating Environment	09
Applicable Road Surface	10
Driving on Road	10
Taking Motor Vehicle	10
Driving Balance	11
Precautions for Getting on/off the Wheelchair	11
Precautions for Reaching out Hands and Tilting Body	12
Putting on Clothes in the Wheelchair	12
Crossing over Obstacle	13
Reverse Driving	13
Drive on Inclined Plane/Slope/Hillside	13
Load Limit	14
Precautions for Getting Up/Down Steps	14
Installation Guide	
Mounting Safety Belt	15
Mounting Control Panel	16
Operation Guide	
Control Panel	17
Use Control Lever to Drive the Wheelchair	18
Use the Horn	19
Braking	20
Battery Use	
Mounting/Removing Battery	22
Charge Battery	22
Overdischarge Protector	23
Overcurrent Protector	23
Battery Socket Cleaning	23
Unfolding and Folding	
Unfold the Wheelchair	24
Fold the Wheelchair	25
Folding the Anti-tipping Wheel	27
Fault & Troubleshooting	29
Guarantee	31
Packing list	33

PL001 electric wheelchair is a transport tool for single person use, which comes in less footprinting and light weight, collapsible, easy to carry, safe & comfortable, suitable for the disabled and senior citizens.

WARNING

★ Users:

Before you have read and understood this Instruction Manual and the electric wheelchair, do not use and operate PL001.

If you have difficulty in understanding the WARNING, CAUTION and instructions, please contact your distributor or qualified technician to obtain professional technical guidance and help; otherwise danger or injury may occur as a result of incorrect operation.

Distributors and Professional Technicians:

Before you have read and understood this Instruction Manual and the electric wheelchair, do not use and operate PL001.

If you have difficulty in understanding the WARNING, CAUTION and instructions, please contact the manufacturer - Suzhou KD Medical Appliance Co., Ltd. to obtain professional technical guidance and help; otherwise danger or injury may occur as a result of misleading the users.

Dear Customers:

Thank you for using our PL001 electric wheelchair. Incorporating innovative design and precision manufacturing, PL001 electric wheelchair delivers excellent safety, comfort and portability to you. As your reliable friend, PL001 will help you enjoy free move and fresh air as you like.

Before you use PL001 for the first time, please read this Instruction Manual carefully and patiently. This Instruction Manual will help you understand PL001's electromechanical properties, operation and maintenance.

If you cannot freely operate PL001 after you have read this Manual, or further help is needed, please contact your distributor or the manufacturer for more complete, specific and professional guidance and help.

Suzhou KD Medical Appliance Co., Ltd.

Appendix

Regional Distributors (if any, the following information will be provided)

Name

Address

Tel

Fax

Email

Manufacturer

Suzhou KD Medical Appliance Co., Ltd.

36 Gugang Road, Chengxiang Town, Taicang, Jiangsu, 215400

Tel: + 86-512-53110088

Fax: +86-512-53110099

Website: www.kd-care.com Email: sales@kd-care.com.cn

The following signs will help you identify and understand PL001's important cautious operation, imperative operation and prohibited operation.



Please read and observe the guidance provided in this manual.



A safety warning sign; or an indication of a dangerous operation that may endanger your safety or other's safety.



Secondary (auxiliary) device



Main part



In the course of operation, do not use mobile, walkie talkie, notebook or other radio transmitters.



Easy to be squeezed/crashed.



Store in clean & dry place protected from rain, snow, ice, salt and water.



Test of immunity to electromagnetism/RF of 30 V/M passed.



Corrosive substance contained in the battery



Danger of explosion



Do not use batteries of different models & capacities, do not use old and new batteries together (replace the battery completely).



When using tools and other metal objects, keep away from the negative and positive poles of the battery; shortcircuit or electric shock may occur if the two poles are contacted.



Inflammable materials, do not expose to heat source such as naked flame or spark; do not transport the battery along with inflammable or explosive material.



Dispose and recycle

Version A

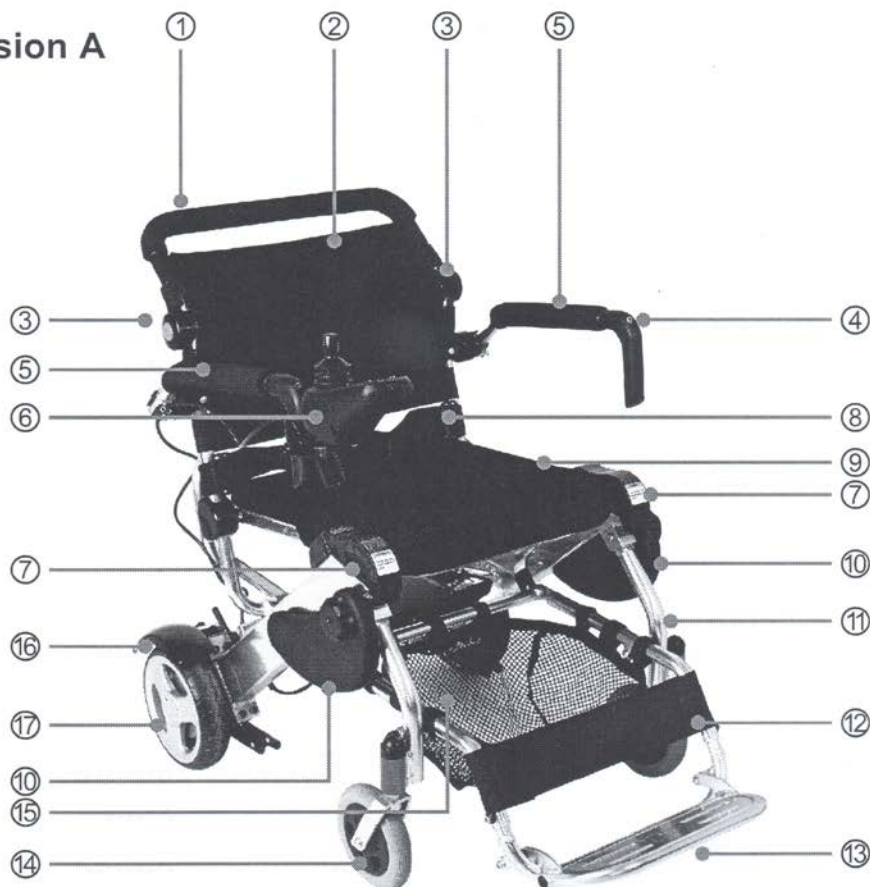

- 1. Upper backrest
- 2. Back cushion
- 3. Backrest-folding button
- 4. Adjustable handle
- 5. Armrest
- 6. Control panel

- 7. Lithium battery
- 8. Safety belt
- 9. Seat cushion
- 10. Leg guard
- 11. Frame
- 12. Leg strap

- 13. Pedal
- 14. Front wheel
- 15. Item storage bag
- 16. Splash guard
- 17. Motor wheel



Version B

Note: armrest difference



- 18. Folding lever cover
- 19. Anti-tipping wheel
- 20. Electromagnetic brake lever
- 21. Control panel gang socket
- 22. Three-link line

- 23. PU armrest finishing
- 24. Cord Anchorage

Model	PL001
Unfolded(L x W x H)	970*590*840mm,(38.2 x 23.2 x 33.1 in)
Folded(L x W x H)	330*590*750mm,(13 x 23.2 x 29.5 in)
Max load	115kg (250 lbs)
Motor	
Type	Brushless DC motor
Rated power	180W
Input voltage	DC 24V
Qty	2 sets
Break system	Smart electromagnetic brake
Breaking distance	At max speed: 0.5 m
Battery	
Type	Li-ion battery
Nominal capacity	10 Ah
Output voltage	DC 24V
Qty	1 set
Controller	
Type	Brushless dual-drive rocker controller
Input power	180W*2
Input voltage/current	DC 24V/12A*2
Front wheel	
OD x tyre width	6" x 2"(150 mm x 38 mm)
Type	Solid tyre
Material	PU
Qty	2
Rear wheel	
OD x tyre width	8" x 2"(200 mm x 50 mm)
Type	Solid tyre
Material	PU/rubber
Qty	2
GW/NW	28 kg(including detachable battery) (60.87 lbs) / 23 kg(including detachable battery) (50 lbs)
Max gradeability	12 degree
Full charge endurance	15 km (9.3 miles) (travel under normal conditions)
Max speed	6 km/h (3.75 mph)
Turning radius	800 mm (31.5")
Max obstacle crossing height	30 mm (1.2")

WARNING

Under specific conditions, electromagnetic interference can cause accident to the electric wheelchair. Therefore, it is important for PL001 users to adequately understand relevant instructions, which can help users take corresponding protection measures to avoid or mitigate the risk to the minimum.

Electric wheelchair is subject to electromagnetic interference. The interference sources comprise electromagnetic waves emitted by broadcasting station, TV station, radio transmitter, two way radio device, mobile and pc; Interference of these electromagnetic waves may result in failure of the control system or the brake system of the electric wheelchair.

CAUTION

-  Though PL001 has passed 30 V/m electromagnetic interference test at factory and has a certain degree of immunity to some common electromagnetic interference in life, user shall still observe the following rule: when the electric wheelchair is powered on in operation, do not turn on or operate portable transceiver, receiver, radio or other communication devices.
2. Keep away from radio wave emission sources as possible, such as radio station and TV station.
3. Where PL001 moves or stops out of control, cut off the power immediately.
4. No modification of any form to PL001 by users is allowed, including adding or removing any parts.

Users

WARNING

-  When using tools and other metal objects, keep away from the negative and positive poles of the battery; shortcircuit or electric shock may occur if the two poles are accidentally contacted.
- Before using PL001, user must read and adequately understand this Manual.
- Escort is required when practicing moving forward, turning, crossing over obstacle and braking etc. until the user can independently and proficiently perform these operations.
- Where safety cannot be ensured, do not try any new operation.
- Check the environment in which PL001 is to be operated for any potential danger and take measures in place to avoid the dangers.

Escort

WARNING

- Cooperate with the user and take advice from the doctor, nurse or therapist to determine safe ways of operation adaptable to the user's ability.
- To move PL001 manually, the electromagnetic brake must be powered off to allow the wheelchair to get into manual state; it shall be noted that the electromagnetic brake will not work at all when it has been powered off.
- When moving PL001 manually, choose safe and reliable point to exert the push force to prevent the wheelchair from tipping over.
- When helping the user cross over obstacle:
 - To prevent the user's back from being hurt, the user shall be maintained in an appropriate position that is in line with human body kinetics. When you lift up or support the user or the tilted wheelchair, you can slightly bend your knees while maintaining your back vertical.
 - To allow the user to be prepared and reduce accident risk, before starting an action, tell the user what you are going to do and explain why; also tell the user what you wish him or her to do.
 - When you are to tilt the wheelchair backwards, remind the user to back against the backrest cushion tightly.
 - When helping the user operate the wheelchair to move up and down the steps within its crossing-over capability, move slowly to avoid damage to the wheelchair or injury to the user due to strong impact.
 - Do not try to cross over obstacles beyond PL001's crossing-over capability.

Precautions for Control Panel Use

⚠ WARNING

1. The locking devices of the control panel need to be frequently checked and adjusted (Fig.A1) to avoid failure of the wheelchair due to collision or loosening of the panel.
2. Where any button on the control panel fails or is not sensitive enough, user must stop using the wheelchair immediately and contact the after-sale service for repair.



Precautions for Static Wheelchair

⚠ WARNING

1. When PL001 is stopped, even for stop of moment only, it must be powered off (Fig.A2), to:
 - Prevent the control panel from being touched accidentally by yourself or others, which may cause the wheelchair to move.
 - Prevent PL001 from interference of accident electromagnetic source that can affect its normal operation.
2. Others except for the user shall not touch the control panel, which may accidentally cause the wheelchair to move.



Operating Environment

⚠ WARNING



This electric wheelchair shall not be used or stored in environment of rain, snow or freeze.

1. Malfunction may occur if the device is in contact with water or in environment of too much moisture; in addition, since the frame, motor and other parts of the wheelchair are not fully waterproof, environment of moisture may result in rusting or corrosion inside PL001.
To prevent malfunction, the following shall be observed:
 - Avoid using or storing PL001 in an environment subject to direct water impact (e.g., rain) or high moisture as possible.
 - Do not use PL001 when you are taking a shower, sauna or swimming.
 - Do not use PL001 around water area (e.g., river, lake or sea).
 - If the control panel has been damaged, replace it before use.
 - Make sure all electric connections are safe and reliably connected.
 - Do not flush PL001 with water. Where the wheelchair has got wet, take out the battery ASAP and allow it to dry naturally. Put the battery back after the wheelchair has been dry.
2. If you have to operate PL001 on wet or smooth ground surface, you must be careful to move slowly, and the following shall be observed:
 - You must be assured that it is safe to do this.
 - If one or two of the main wheels have lost its tractive force, you must stop immediately to prevent the wheelchair from getting out of control or tipping over.
 - Do not drive into slope or ramp covered with snow, ice, water or oil layer or stain.
3. When the wheelchair is not in use, turn off its power, charge the battery full and keep it at a clean and dry place.

Applicable Road Surface

WARNING

1. PL001 is designed for road surfaces of concrete, pitch and indoor ground floor only.

Do not use PL001 on sands, loose earth or rough road surfaces to prevent the wheel, bearing, axis or motor etc. from being damaged or fastening piece from loosening.

Road Driving Environment

WARNING

Observe local traffic regulations when driving on public roads.

User must be aware of that when PL001 is used on public roads or parking lots, external risk of uncertainty exists.

1. For easy identification in the night, PL001 is provided with reflecting tag (Fig. B1). It is also recommended that user shall wear reflecting clothes when driving at night.
2. When encountering other vehicles, make sure the driver can see you, and maintain yourself in a safe position.

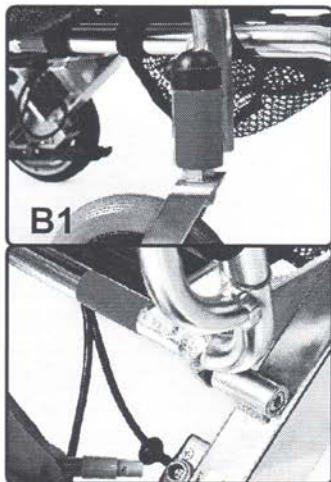

Taking Motor Vehicle

WARNING

1. Do not use PL001 when taking bus, metro, train, plane or ship if possible.
2. If you have to use PL001 when taking such vehicles, you must tie the safety belt in place, and try to find a place where you can fix the wheels or the wheelchair to prevent from being damaged when the vehicle brakes or a traffic accident happens.
3. Do not place PL001 at the front area of the vehicle, this may cause interruption to the driver.
4. When getting on or off the vehicle, do not lift the user together with the wheelchair if possible; If you have to do this, hold the front and rear edges of the seat cushion frame, do not hold the armrest or the rear backrest of the wheelchair to lift.

Driving Balance

WARNING

When driving PL001, try to maintain the balance of the gravity center and stability to avoid tipping over in the course of moving forward or backward.

The balance of the gravity center is generally subject to the following factors:

1. Height and angle of the chair
2. Changes of the position, state or weight of the user's body
3. The gradient of the ramp or slope
4. Articles carried also may change the distribution of the overall weight of the wheelchair.



Caution: do not modify or adjust PL001's configuration or construction yourself.

Precautions for Getting on/off the Wheelchair

WARNING

It's potentially dangerous for user to move his or her own body. Whenever you try to move your body, you must have a supporting point that is not lower than the level of your seat cushion. To avoid tumble, the following shall be noted:

- ★ 1. Turn off the power first when you are to get on the electric wheelchair; otherwise you may touch the control panel and may cause unexpected accidental movement of the wheelchair.
- 2. Make sure the motor has been locked and the wheelchair will not automatically move.
- 3. Learn from your health care professionals the safest way to move your body.
- 4. Move your wheelchair close to your target position to seat as close as possible. Where possible, use relevant auxiliary tools.
- 5. Rotate the front wheels to make them close to the front as possible.
- 6. Be careful about the pedal. Fold it up when possible (Fig. C1).
 - Do not stand on the pedal to move your body to avoid any injury.
 - Make sure your feet are not tangled or clamped in the gap between the pedals.
- 7. Make sure you are not intervened by the armrests or guard plate (Fig. C2).
- 8. You should try to get onto the seat as quickly as possible, this reduces the risk of falling down due to missing the seat.

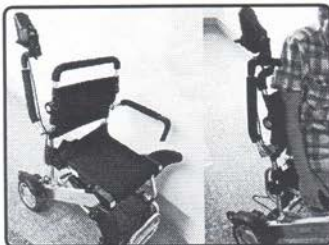

Precautions for Tilting/Extending Body

WARNING

Reaching out hands or tilting body will influence PL001's balance of the gravity center. If not operated correctly, you may fall off or the wheelchair may tip over.

The following are key points for reducing risk of damaging or breaking the wheelchair:

1. Where you have to change the gravity center of your body, such as lifting your body at one side or leaving the seat, do not tilt your body out of the range of the seat cushion.
2. where you have to move forward on your seat, do not tilt your body too much (Fig. C1), your bottom must be always in contact with the seat cushion.
3. Do not reach out your hands to articles that are almost beyond your reach to avoid falling down due to lost balance.
4. Under no circumstances should you try to pick up article through the space between your two knees or from front of your body (Fig. C2).
5. When you extend your body, do not exert force on the pedals to avoid the wheelchair from tipping over, which may result in serious injury.
6. Do not rest against the top of the backrest to avoid tipping over or damage to the backrest.

If you have to do this, the risk is on your own.



Putting on Clothes in the Wheelchair

WARNING

Caution: when you are putting on clothes in PL001, your body may turn. To make the wheelchair more stable, you should adjust the front wheel to a forward position.

Crossing over Obstacle

WARNING

You may have to overcome some daily obstacles, such as threshold, elevator, slope, pits and rough roads. Incorrect operation may result in damage of your electric wheelchair or injury of yourself.

1. Threshold can be dangerous; even a small change of height can block the front wheel, tilting or tipping over the wheelchair, therefore it is recommended to:
 - Remove the threshold of the room or cover it to allow the wheelchair to cross over slope.
 - Install a slope door.
2. When you are moving PL001, check the area to pass carefully to ensure safety.
3. You can adjust your gravity center like this:
 - When you are to cross over an obstacle, tilt your upper body slightly forward.
 - When you are crossing a gradient section from high to low, your upper body shall back against the backrest.

Reverse Driving

WARNING

When you drive PL001 to travel reversely, you must be very careful. If the rear wheel runs to an object, you may lose control or tumble.

Caution:

1. When you are driving reversely, slow down as possible.
2. Stop from time to time to check and ensure the road surface you are to cross over has no potentially dangerous obstacles.

Drive on Inclined Plane/Slope/Hillside

WARNING

When you are driving PL001 on slope, your gravity center may change.

If you are not 100% sure that it's safe to drive PL001 on slope, please drive with the help of others, do not drive on your own.

The following shall be noted:

1. It is not advisable to drive PL001 on slope over 10°, and it is prohibited to drive on slope over 12°.
2. It is also prohibited to drive PL001 on wet slippery slope (e.g., the slope are covered with snow, ice, water, oil layer or stain).
3. For slope with ups and downs (pits or heaves), do not use PL001.
4. If there are pits at the bottom of the slope, do not use PL001.

Load Limit

WARNING

1. Max load of PL001 is 115 kg (250 lbs), which shall not be exceeded in the course of application.
2. The safe load of PL001's backrest is 75 kg, do not press down or lift up the backrest.
3. Under no circumstances should the user do weight training on PL001.
4. Overload application may result in damage of chair, frame, fastening pieces and folding devices etc. It can also cause serious injury to the user or others, or even totally destroy PL001.
5. For problem due to overload, no guarantee is provided.

Precautions for Getting Up/Down Steps

WARNING

PL001 is not designed for long journey, getting up and down steps and elevators.

1. It is prohibited to move or use PL001 on elevators (stepped elevator), which may result in serious personal injury.
2. To seat on PL001 and use lifters is allowed, however, the lifter door must be kept open when the wheelchair moves in/out of the lifter.

Mounting Safety Belt

WARNING

The safety belt is for fixing user's body only and prevent the user from falling off the chair. Where an accident occurs, it cannot provide adequate protection for you.

Mounting safety belt:

1. Lead the head of the safety belt through the middle space between the reinforcement tubes at the left and right backrests under the rear part of the chair (Fig. D1).
2. Attach AB buckle to the belt (Fig. D2).
3. Clip the plastic safety buckle into the place where the AB buckles are attached (Fig. D3).

• Adjust the safety belt until user feels comfortable.

1. After seating in, snap the plastic card into the plastic casing at the other side until a click sound is heard.
2. Adjust the safety belt at the plastic card to appropriate length, it shall not be too tight, otherwise you may feel uncomfortable.

Unlock the safety belt:

- Press the button at the end of the plastic casing and pull the plastic card out.

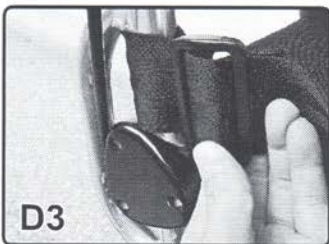
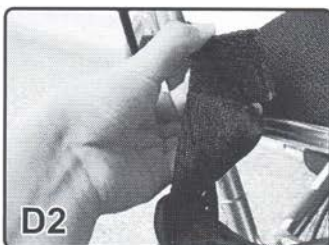

CAUTION

Every time before use, make sure the safety belt is appropriately fixed onto the wheelchair and adjusted to the most comfortable the user feels.

Every time before use, check the safety belt for any loosening or breaking. If any problem is found, contact the after-sale service for maintenance or repair.

Mounting Control Panel

Depending on user's demands, the control panel can be mounted on the right or left armrest. As shown in Fig. E1, sleeve the quick release clamp of the control panel onto the plastic grab bar and lock the quick release handle tight.

1. As shown in Fig. E2, connect the wires of the control panel into the cord anchorage and fix them.
2. As shown in Fig. E3, align to the notch of the socket, plug the four-core plug of the control panel into the socket at the other side.
3. As shown in Fig. E4, mounting can be done at either the left side or right side of the control panel. When the plug is pulled out, put on the dust cap.

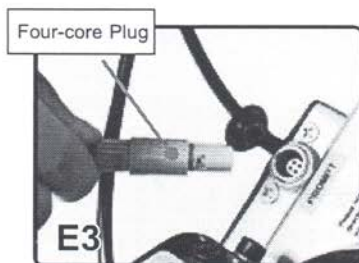

Control Panel



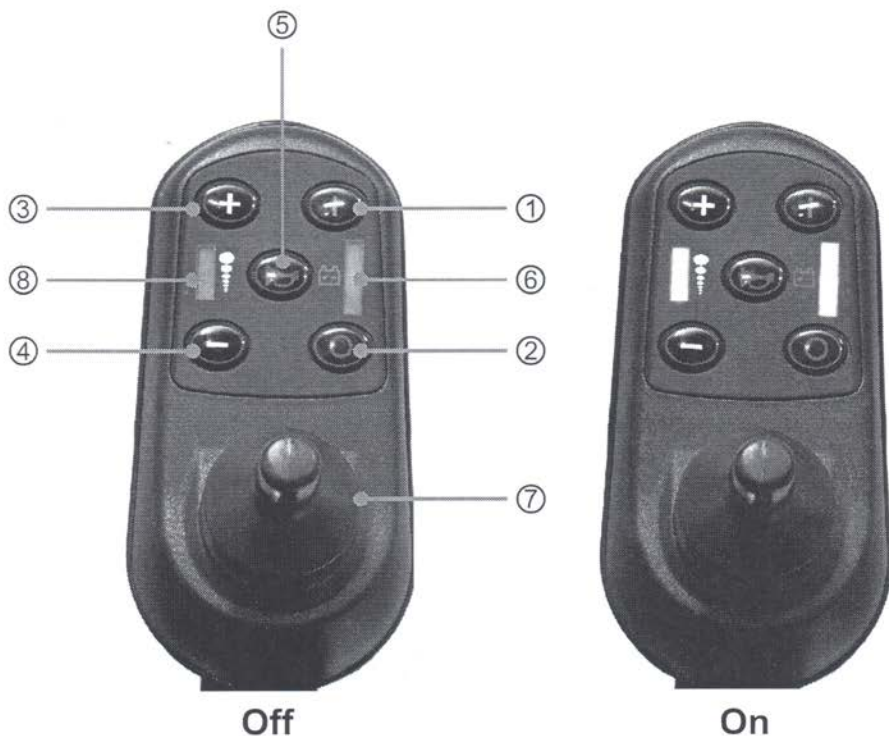

The control pangel comprises the following:



1. Power-on button:
Press this button to power on the wheelchair.
2. Power-off button:
Press this button to power off the wheelchair.
3. Speedup button:
Press this button to speed up. The max speed is 6km/hr (3.75 miles/hr).
4. Slowdown button:
Press this button to slow down.
5. Horn:
Press the horn to sound.

6. Battery power LED:
indicating battery power status.
7. Control lever:
the control lever controls the direction and speed of the wheelchair, push the lever towards the target direction.
8. Speed/diagnosis information LED:
When the light is on, PL001 is working, specific indication of the lights: five lights totally. Where one LED is on, it's at the lowest speed, whereas all five are on, it's at the highest speed.

If the LED flashes intermittently, it's indicating diagnosis information. Refer to the table below for specific indications:

	The lowest LED flashes: low power
	The second LED flashes: the control lever has no signal
	The third LED flashes: charging, under control
	The fourth LED flashes: Motor connection failed
	The fifth LED flashes: electrodynamic braking disconnected

Press Power On/Off Button

1. Press the power on button to power on the wheelchair.
2. Press the power off button to power off the wheelchair.

Use Control Lever to Drive the Wheelchair

WARNING

Do not do sharp turns at high speed.

Otherwise the wheelchair may tilt, resulting in injury to user or damage to property.

The control lever is at the back of the control panel, which controls the speed and direction stably. It provides 360-degree omnibearing moveability for easy operation. A spring is arranged inside the control lever, which automatically returns to the initial middle point state.

Push the control lever towards the target direction. The control lever can control the drive proportionally, the harder the push is, the faster it goes. The max traveling speed is 6km/hr (3.75 miles/hr).

To slow down, just release the control lever, the wheelchair will slow down.

When you learn to drive this wheelchair for the first time, you should choose a slow speed pushing the control lever slowly forwards. This will help you learn how to control the wheelchair and understand the control force step by step until you are familiar with starting and stopping the wheelchair.

Before using the wheelchair, please do the following operation:

1. Set the control panel to appropriate settings.
2. Power on. Refer to the Section - Press Power On/Off Button for operation.
3. Move the control lever as follows:

Movement	Control lever operation
Forward	Push the control lever forward
Backward	Pull the control lever backward
Right	Push the control lever to the right
Left	Push the control lever to the left
Stop	Release the control lever (the wheelchair will slow down quickly)

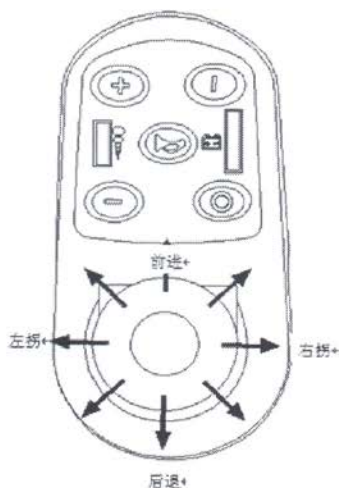

Use control lever to move the wheelchair

Use the Horn

Press the horn button on the control panel to sound when passing through crowds.

After any adjustment, repair or maintenance, check all components and parts for tightness before use, otherwise damage or injury may occur.

Only when the power is off, shall the electromagnetic brake be allowed to be started or closed.

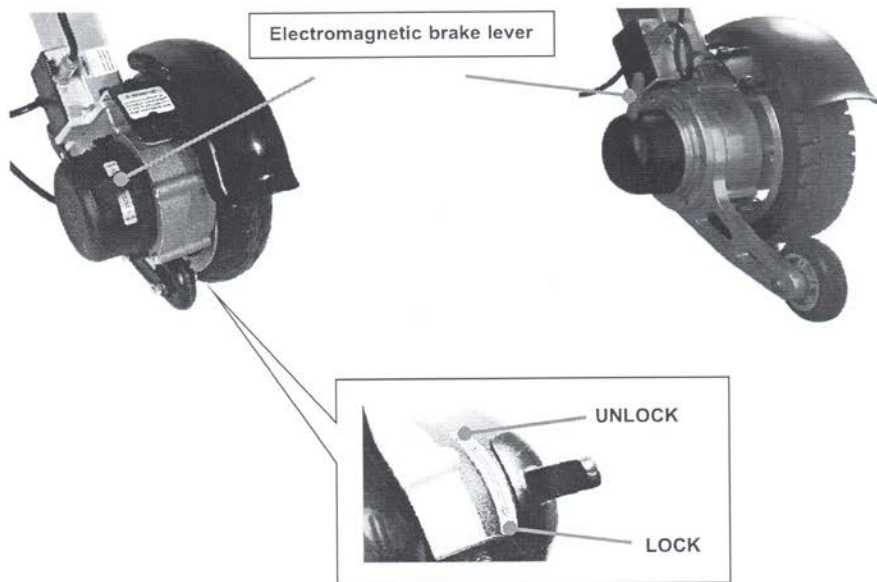

Electromagnetic brake states:

This wheelchair has two states: LOCK and UNLOCK, which are switched through turning the brake lever.

LOCK state indicates that the internal clutch of the electromagnetic brake is engaged and the electromagnetic brake is started. Before powering on and operating the control lever to a direction, the motor wheel will not rotate, purpose: when user is getting on/off the wheelchair, this will make sure the wheelchair will not move, and can even stop or start on slope.

UNLOCK state indicates that the internal clutch of the electromagnetic brake is disengaged and the electromagnetic brake is closed without braking. In this state, the motor wheel can rotate even when the power is off. Purpose: allow to move the wheelchair manually.

☐ **Caution:** before using the wheelchair, make sure the electromagnetic brake works normally, and the brake lever is in LOCK state

  Do not use batteries of different models & capacities, do not use batteries of different brands or types. Do not use old and new batteries together.

 The positive and negative poles of the battery shall not be connected by conductive object such as metal, otherwise short circuit may occur, resulting in possible accident injuries such as electric shock.

 Keep away from inflammable material Keep away from heat source and do not expose to heat source, such as naked flame or spark. Do not transport the battery along with inflammable or explosive material.

 The battery pack contains corrosive chemicals, do not disassemble the battery yourself.

 Battery shortcircuit is strictly prohibited, do not put battery into fire, explosion may occur as a result.

WARNING

1. Do not attempt to connect the battery terminal directly using plier or metal cable to charge the battery.
2. Do not use the wheelchair when the battery is being charged.
3. Do not use non-standard power supply (eg. generator or inverter) even their voltage and frequency seem correct.
4. The power cord shall be prevented from treading, squeezing, serious bending, jerking or knotting.
5. Keep the power cord away from children or pet otherwise they may bite or chew the cord. When pulling the power cord, grab the plug to pull it out.
6. If the circuit breaker (fused switch) trips for times in the course of charging, pull out the charger immediately and contact the distributor or professional technician.
7. PL001 has an electronic drive-locking device preventing the wheelchair from operation when it is being charged.
8. Do not smoke or ignite around the battery.
9. The operating temperature of the battery is -5°C to 40°C.

CAUTION

1. Charging the battery continuously for a long time before the first use can reduce the battery's service life (charge the battery for the first time only when the last red LED on the control panel flashes, in this way, can the battery be fully activated.)
2. For charging new battery for the first time, it must be fully charged (about 24 hrs) to ensure the battery to be fully activated.
- ★ 3. Check if the battery has been fully charged before use, charge it if the battery is in low power. For battery of non-first-use, the charging time is about 5 hrs; if the power has been fully run out, it takes 10-12 hrs to charge to full until the red LED on the charger turns green.
4. The recommended charging time for the battery is 8-12 hrs.
- ★ 5. Whenever the wheelchair is used, the battery shall be recharged until the power LED on the charger turns green. If the wheelchair is not in use for a long time, charge the battery full every 2 months; if the battery has no power for a long time, the battery can be damaged and is not usable anymore, or even cause damage to the wheelchair.
6. Battery of incorrect specification, voltage or capacity is strictly prohibited to use, which may damage your wheelchair or the wheelchair will not be able to achieve its optimum performance.

Use Control Lever to Drive the Wheelchair

⚠ WARNING

Do not do sharp turns at high speed.

Otherwise the wheelchair may tilt, resulting in injury to user or damage to property.

The control lever is at the back of the control panel, which controls the speed and direction stably. It provides 360-degree omnibearing moveability for easy operation. A spring is arranged inside the control lever, which automatically returns to the initial middle point state.

Push the control lever towards the target direction. The control lever can control the drive proportionally, the harder the push is, the faster it goes. The max traveling speed is 6km/hr (3.75 miles/hr).

To slow down, just release the control lever, the wheelchair will slow down.

When you learn to drive this wheelchair for the first time, you should choose a slow speed pushing the control lever slowly forwards. This will help you learn how to control the wheelchair and understand the control force step by step until you are familiar with starting and stopping the wheelchair.

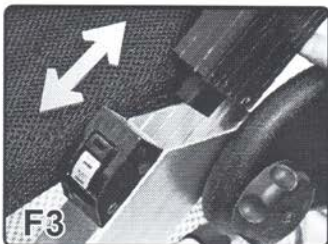
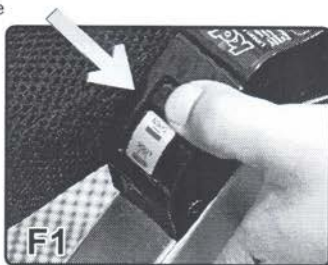

Charge Battery

1. The battery can be charged with normal AC power (AC 110-220 V, 50-60 Hz), the charging port is under the front part of the control panel.
2. Make sure to power off the wheelchair before charging the battery.
3. Plug the charging port of the charger into the charging port under the front part of the control panel (Fig. F2).
4. Plug the end of the charger for external power source into the power outlet. When the red LED is on, it is charging.
5. When the LED on the charger turns from red into green, keep charging for a further more 30 minutes to allow the battery to be fully charged. Unplug from the power outlet of the external power source first, then unplug from the control panel.
6. Please charge the battery in an appropriate ambient temperature, the recommended ambient temperature for charging is between 5° to -40°.



Overdischarge Protector

★The characteristics of the lithium battery determines that when it is completely run out, it will not be able to work again. Therefore, an overdischarge protector is provided in PL001. When the lithium battery is running out, the protector will cut off the circuit automatically, and the controller will stop working. User shall be noted that when the red power LED on the control panel flashes, the battery shall be charged in time; if the red LED has gone out, the battery must be charged within 2 hrs, otherwise the battery may not be activated by the charger, and may be totally destroyed. The charging time after overdischarge takes 10-12 hrs.



Overcurrent Protector

PI001 is also provided with an overcurrent protector. If the current supplied to the motor is too high, the controller will close the current. If the slope is over 12 degree, the load is over 115KG or the motor rotation is blocked, the overcurrent protector will be activated, the wheelchair controller will cut off the circuit to prevent overcurrent and overheating of the motor, the red signal LED on the control panel will flash and the buzzer will sound.

Battery Socket Cleaning

⚠ WARNING

1. Check the battery pack and the positive and negative poles for any corrosions, if any, clean it with battery cleaning tools, steel brush or medium sand paper. Note: when it is clean, it shall be bright and dry.
2. Clear all metal particles carefully.
3. Check for correct assembly of the battery and the plastic battery pack.

Caution: do not allow the substance inside the battery to contact skin, clothes or other articles. It's acid substance, which may cause hazardous or destructive burning. If it has contacted your skin, flush thoroughly with cold water. For serious situation or if your eyes get contacted, seek medical help immediately.

WARNING

After any adjustment, repair or maintenance, tighten all components and parts, otherwise damage or injury may occur.

PI001 (including removable battery) weighs about 23kg (50.6lbs), please use correct lifting ways to avoid injury. It is strongly recommended to get the user off the wheelchair before lifting or handling the wheelchair; If to handle the wheelchair with the user together, you must be very cautious, at least two persons are required to handle them together and the front and rear edges of the seat cushion frame shall be held.

Unfold the Wheelchair

For the first use or to use it again when it has been folded and kept in place, please operate as follows:



1. As shown in Fig. G1, pull out the wheelchair by holding the position shown in the figure in the arrow direction without pulling to the full (pulling to the full will get the splash guard collided and damaged by the armrest).
2. Turn the pedal as directed by the arrow in Fig. G2, and turn the two armrests to level position as directed by the arrow in Fig. G3.

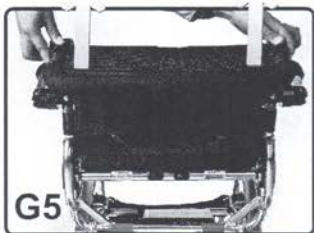
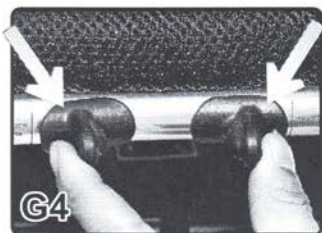

Anti-tipping wheel limit button

3. Pull the backrest backwards to the rear edge of the seat cushion until the two folding lever covers reach the red line position (Fig. G4) and a click is heard, the whole wheelchair has been unfolded.
4. As shown in Fig. G5, press the backrest-adjusting button and turn the backrest in the direction shown in the figure to appropriate angle until a click is heard.
5. As shown in Fig. G6, press the anti-tipping wheel limit button and pull out the anti-tipping wheel. (refer to the instruction on Mounting Control Panel)



6. Install the control lever and plug in the four-core plug in accordance with Fig. G7. (refer to the instruction on Mounting Control Panel)
7. Place the wheelchair on road and get on/off the wheelchair, as shown in Fig. G8.

Fold the Wheelchair

After using this product, for storage or transport, fold it up in accordance with the following steps

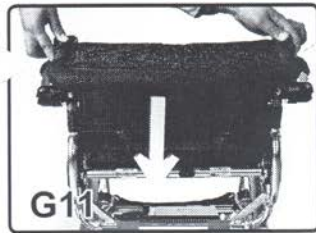

1. Remove the control panel in accordance with Fig. G9.
2. Press the anti-tipping wheel limit button in accordance with Fig. G10 and retract the anti-tipping wheel. (refer to the anti-tipping wheel folding method)
3. Press the backrest-adjusting button as shown in Fig. G11 and turn the backrest in the arrow direction to the state as shown in Fig. G12.



4. Turn the armrest in the arrow direction as shown in Fig. G13
5. Loosen the knob as shown in Fig. G14 and turn the leg guard to the bottom.
6. As shown in Fig. G15, hold the folding lever cover and push the backrest forward to a position as shown in Fig. G16.

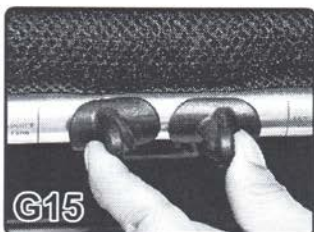
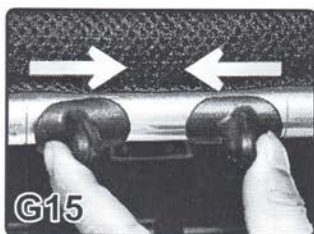

7. Press the wheelchair tight by holding the position and in the arrow direction as shown in Fig. G16 until as shown in Fig. G17.

Folding the Anti-tipping Wheel

Version A

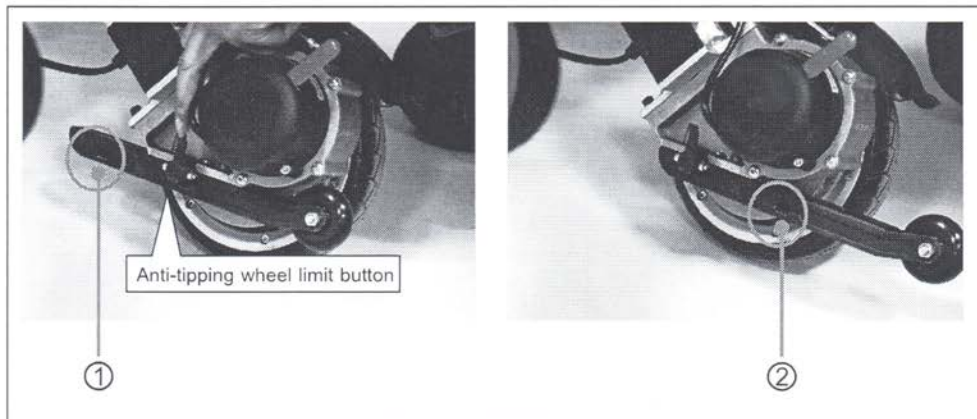

- Operating steps: 1. As shown in Fig. H1, press the anti-tipping wheel limit button, pull out the anti-tipping wheel to the position of hole ①.
2. As shown in Fig. H2, press the anti-tipping wheel limit button, retract the anti-tipping wheel to the position of hole ②.

Folding the Anti-tipping Wheel

Version B

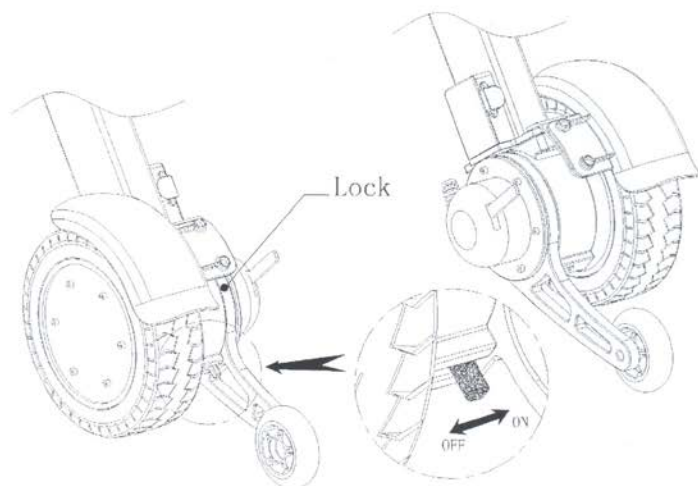

User mode

The action principle is as shown in the figure below: When it is in application, press the button and turn to level with the supporting point A as the center, the elastic pin goes into the hole and it is locked.

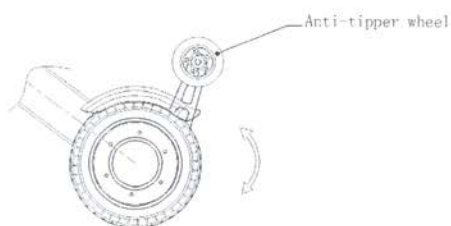

Folding

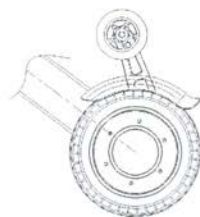

Folding

WARNING

Before using the wheelchair, make sure the anti-tipping wheel is unfolded.

Also make sure the lock bar of the locking device is in place, otherwise the safety can be compromised.

A diagnosis information LED is provided on the control panel. When that LED is in green, the wheelchair is trouble-free. Where a failure occurs, relevant LED will flash to indicate.

When a fault is indicated by the LED, turn off the power first and turn it on again.

If the trouble still exists after restartup, and the LED repeats indication of the fault, please refer to fault diagnosis information table to find out possible causes and solutions.

If all the above have been tried and the trouble still exists, contact the distributor. When communicating with the distributor, describe the specific symptom and provide relevant information on the fault as possible

Fault Diagnosis Information Table

No.	Fault	Possible cause	Solution
1	Power problem	1.Faulty connection of the control panel and the plug	Re-plug the four-core plug into the socket at the side of the chair
		2.Low power, or power supply automatically cut off	If the power has been automatically cut off, it must be recharged within 2 hrs. Charge for 10-12 hrs.
		3.Fault of the two-core plug connecting to the battery	Take out the battery and check the contact for any fault and re-plug the battery
2	Fault of control panel	The lowest LED flashes: low power	Charge
		The second LED flashes: the control lever has no signal	Re-plug the plugs of the two ends of the power cord of the control panel, or replace the control panel.
		The third LED flashes: Charging	When it is charging, do not use the wheelchair, please wait patiently for it to be fully charged.
		The fourth LED flashes: Motor connection failed	Replug & tighten the motor connector
		The fifth LED flashes: The electromagnetic brake is disengaged and is not working.	Push the electromagnetic brake at the motor upward to lock state
3	Electromagnetic brake fault	1.When the power is off, and the electromagnetic brake is in lock state, the motor can still rotate	Contact the customer service to replace the electromagnetic brake
		2.When the power is on, and the electromagnetic brake is in lock state, the motor cannot rotate	Contact the customer service to replace the electromagnetic brake
		3.When the power is off, and the electromagnetic brake is in unlock state, the motor cannot rotate	Contact the customer service to replace the electromagnetic brake
4	Motor fault	Strong noise and vibration occur in the course of motor run	Contact the customer service
5	Distance per charge decreased	1.Low temperature environment below 0°C	It's normal as lithium battery characteristics
		2.Drive on roads or slopes of ups and downs	It's normal as such places will consume more battery power
		3.Battery use has exceeded its service life	Contact customer service to replace the battery
6	Fault with charging	1.Faulty connection of the control panel and the plug	Re-plug the four-core plug into the socket at the side of the chair
		2. Controller broken	Contact customer service to replace controller
		3. Charger plug broken	Contact customer service to replace charger
		4. Charging plug loosened	Recheck and tighten
7	Non-operating at "on" state	Potential overprotection after not using for a period or after charging	Use after "on" and "off" state

Fault Diagnosis Information Table

Guarantee Instruction:

Items of guarantee	Free guarantee time	Remark
Main frame	5 years	For fault due to incorrect use, damage by the user or self-modification, no guarantee is provided or maintenance costs will be charged.
Motor unit	2 years of guarantee for the motor, 1 year guarantee for the tyre and other components	No guarantee for motor damage due to overload or dismantling by the user
Battery	1 year of guarantee for the lithium battery	No guarantee for damage due to incorrect charging or self-dismantling. We are not responsible for accident caused thereof either.
Controller	1 year	For fault due to incorrect use, damage by the user or self-modification, no guarantee is provided or maintenance costs will be charged.
Control Panel	1 year	For fault due to incorrect use, damage by the user or self-modification, no guarantee is provided or maintenance costs will be charged.

Non-guarantees:

1. The following situations are non-guarantees:
 - a) Wearing or damage of the backrest, seat cushion, armrest styrofoam, backrest styrofoam and decorating parts due to normal use.
 - b) Damage due to negligence, accident, misuse, incorrect installation or repairing.
 - c) Fault due to self-modification without consent in writing by Suzhou KD.
 - d) Damage due to overload.

2. If the SN on the wheelchair is not original or is modified, or is inconsistent with that on the guarantee card, or the SN on the guarantee card is altered, no guarantee will be provided.

3. The guarantee card is non-transferable and is for the purchaser of the wheelchair only.

As the manufacturer, our responsibility is to repair or replace damaged parts.

To the extent permitted by law, this guarantee instruction supersedes any other guarantees, such as writing, oral, expressive or implicit guarantees, including guarantees of any merchantability or applicability of special purpose, for any conflicts between the same, this guarantee instruction shall prevail.

Packing list

Name	Qty	Remark
Main wheelchair frame	1	/
Lithium battery	2	/
Control Panel	1	/
Charger	1	/
Instruction manual	1	/
Vido tutorial	1	/
Tool bag	1	/
Certificate of inspection/guarantee card	1	/



ShangHai KD Health Care Co., Ltd. (Distributor)

Address:

Customer service: 400-820-7665 Post code: 215400

Suzhou KD Medical Appliance Co., Ltd. (Manufacturer)

Address: 36 Gugang Road, Chengxiang Town, Taicang, Jiangsu

Tel: 0512-53110088 Fax: 0512-53110099 Post code: 215400

Website: www.kd-care.com E-mail: sales@kd-care.com.cn